



Installation Instructions

For Part Numbers:

510-163	700-458 Airaid Oiled Media Filter
511-163	701-458 SynthaMax Dry Media Filter - Red
512-163	702-458 SynthaMax Dry Media Filter - Black
513-163	703-458 SynthaMax Dry Media Filter - Blue

2000-04 Toyota Tundra
2001-04 Toyota Sequoia
4.7L V8

Component Identification

1.	Airaid Premium Filter	1
2.	MAF Panel	1
3.	Back Panel	1
4.	MAF Adapter	1
5.	Modular Intake Tube	1
6.	Reducer Coupler	1
7.	Urethane Hump Hose	1
8.	1/2"x13" Breather Hose	1
9.	3/8" x 17" Hose	1
10.	Weather Strip 26 3/4"	1
11.	#52 Hose Clamp	2
12.	#56 Hose Clamp	1
13.	#60 Hose Clamp	1
14.	1/4" Barb x 1/8" NPT	1
15.	1/4" x 1/4" x 1/8" Vacuum Tee	1
16.	1/4" x 4" Hose	1
17.	6-32 x 5/16" Screw	3
18.	#6 Flat Washer	3
19.	6-32 Keps Nut	3
20.	1/4 - 20 Button Head Bolt	3
21.	1/4" Flat Washer	3
22.	8-32 x 1/2" Button Head Bolt	2
23.	1/4" x 1/4" x 3/8" Tee	1
24.	Speed Clamp	1
25.	Airaid Decal	1

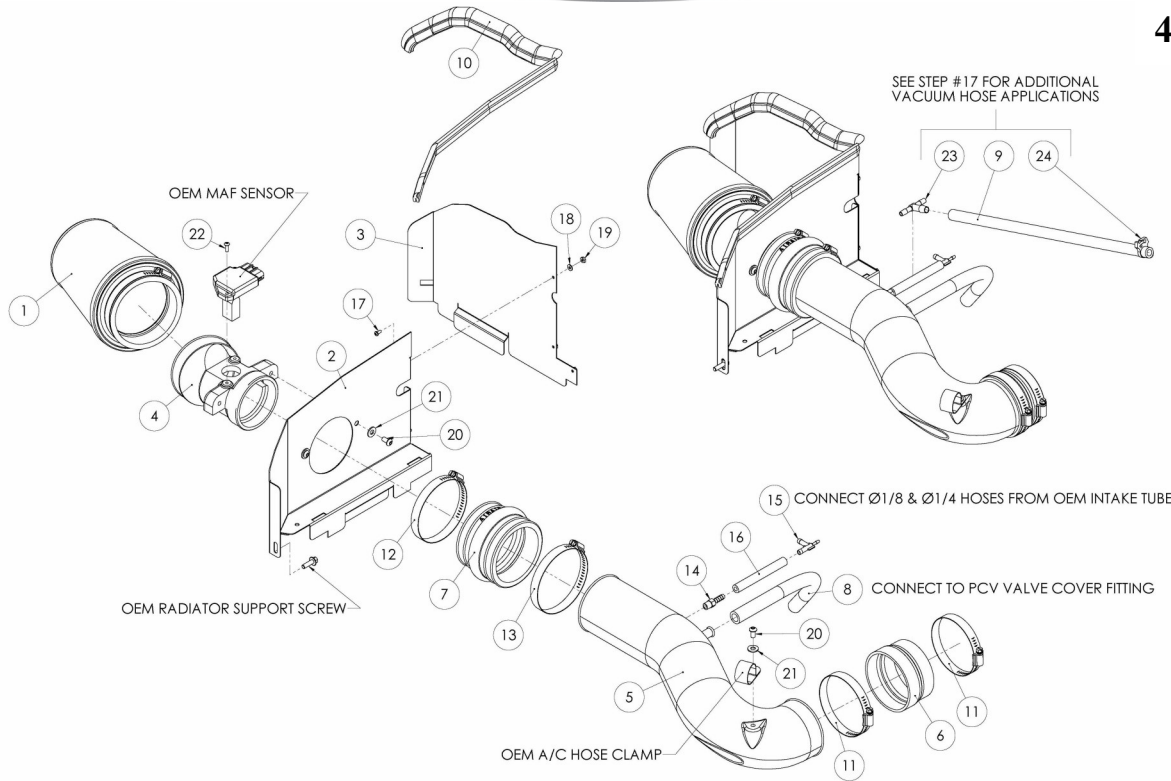

This kit is only legal for sale in California for 2000 thru 2002 Toyota Tundras, and Sequoias. 2003 and 2004 Tundras, and Sequoias do not have C.A.R.B. exemption status.

Full color instructions can be viewed on our web site at Airaid.com.

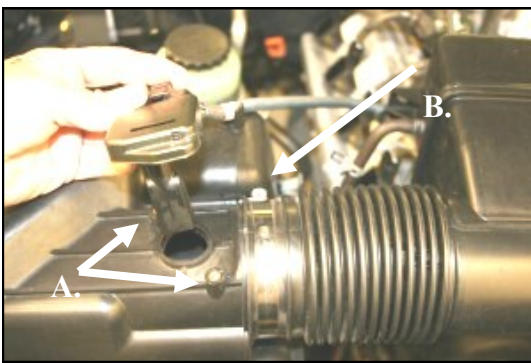

1. Stage I

Disconnect the negative battery cable!

A) Remove the two screws, and remove the Mass Air Flow (MAF) sensor from the factory airbox. Leave the wiring harness connected, and set it aside. B) Loosen the hose clamp on the intake tube



2. Unlatch the 4 clips on the factory airbox, and remove the lid. Remove the factory air filter.



3. Assemble the Airaid Cool Air Dam (CAD) panels (#2, #3) using three 6-32 x 5/16" screws (#17), #6 flat washers (#18), and 6-32 keps nuts (#19). Install the MAF adapter (#4) using two 1/4 - 20 button head bolts (#20), and 1/4" flat washers (#21). Apply the Airaid Foil Decal onto the Panel as shown.



4. Remove the fan shroud bolt from the passenger side of the radiator. (Save for reuse).

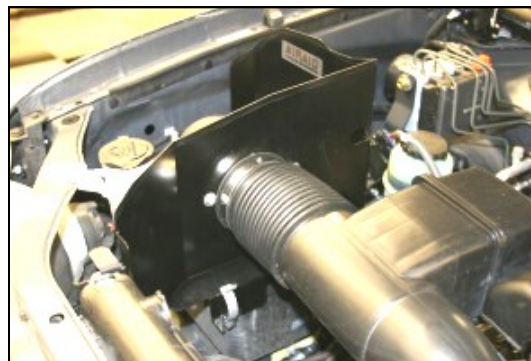

5. Slide the MAF adapter into the factory tube, and at the same time slip the CAD onto the top of the factory airbox base, adjust for fit and re-latch the 3 factory clips. Tighten the hose clamp on the factory intake tube. Reinstall the shroud bolt from step #4.

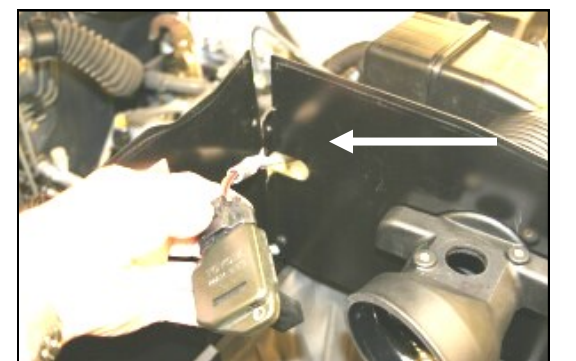

6. Remove the top screw on the CAD. Spread the panels slightly, and slip the wiring harness thru the gap into the access hole, as shown. Re-install the screw and tighten.



7. Install the MAF sensor into the MAF adapter (#4) and tighten down using two 8-32 x 1/2" button head bolts (#22). **Do Not Use The Factory Screws!**



8. Install the Airaid Premium Filter (#1) onto the MAF adapter. Next install the weather strip (#10) on top of the CAD. Start at the radiator end and work you way towards the back.

9. Stage II

For maximum airflow and aggressive sound from your vehicle, proceed with installing the Airaid Modular Intake Tube (#5). The MIT can be added or taken off of your vehicle at any time depending on your preference. If you choose not to install the MIT, skip to step #19 on the back page.

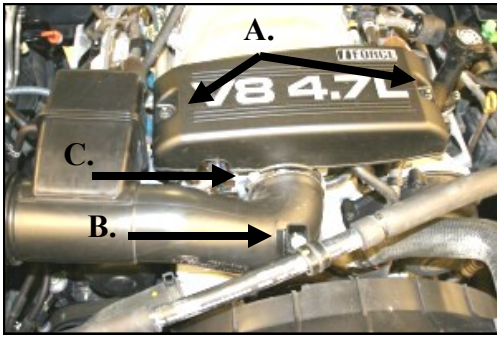

10. A) Using a 10mm socket, remove the two nuts and remove the beauty cover. (Save for reinstallation.) B) Remove the bolt thru the Adel clamp for the air conditioning hose. C) Loosen the hose clamp on the factory intake tube at the throttle body and the airbox if it was tightened in step #5.

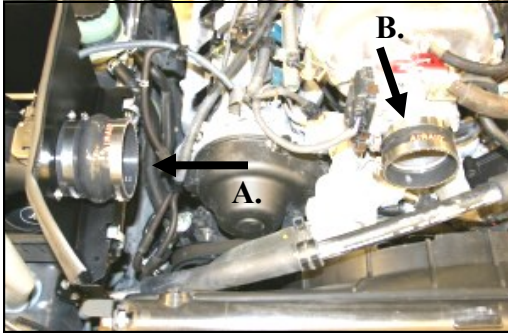

13. A) Install the urethane hump hose (#7) onto the MAF adapter (#4). Use the #56 hose clamp (#12) on the MAF adapter end, and the #60 hose clamp (#13) on the intake tube end. B) Install the reducer coupler (#6), small end towards the throttle body with two #52 hose clamps (#11). Leave the clamps loose for now.

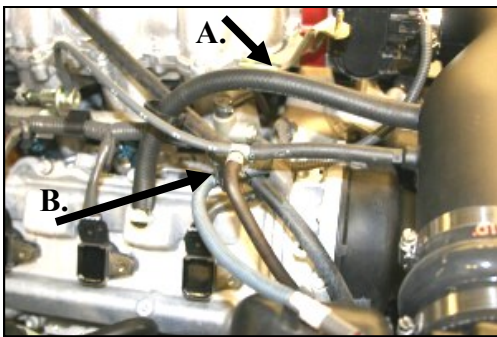

16. 03-04 Tundra, 04 Sequoia
A) Install the 1/2"x13" breather hose (#8) from the MIT to the valve cover. B) Install the 1/4" x 1/4" x 1/8" vacuum tee (#15) into the 1/4" x 4" hose (#16) and then into the factory 1/4" vacuum hose, and 1/8" vacuum hose as shown. Refer to the hoses in step #11. Reinstall the beauty cover from step #10.

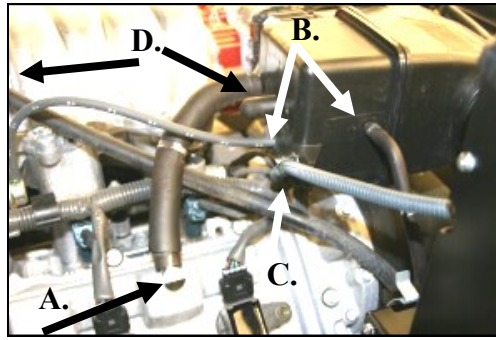

11. A) Disconnect breather hose at the valve cover. B) Disconnect 1/4" and 1/8" vacuum lines on the back of the factory intake tube. C) Unclip MAF wire harness retainer from the intake tube. D) 01-03 Sequoias and 00-02 Tundras only; remove 3/8" vacuum hose between factory intake tube and metal fitting on top of the intake manifold. (Hose Not Shown)

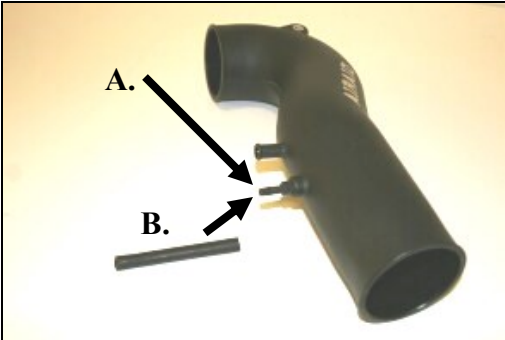

14. A) Install the 1/4" Barb x 1/8" NPT fitting (#14) into the Airaid Modular Intake Tube (MIT) (#5). B) Next, slip the 1/4" x 4" hose (#16) onto the barb fitting.

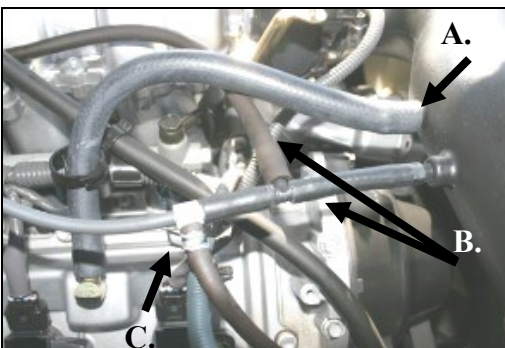

17. All Other Applications
A) Install the 1/2" x 13" breather hose (#8), from the MIT to the valve cover. B) Cut the 1/4" x 4" hose in half, and install the 1/4" x 1/4" x 3/8" tee (#23) between the two halves. Connect the 3/8" x 17" hose (#9) between the tee, and the factory metal fitting above the intake manifold. Squeeze the speed clamp (#24) over the hose at the factory metal fitting. (not shown) C) Install the vacuum tee (#15) into the 1/4" x 4" hose (#16) and then into the factory 1/4" vacuum hose, and 1/8" vacuum hose as shown. Refer to the hoses in step #11. Reinstall the beauty cover from step #10.



12. Remove the factory intake tube.



15. Install the Airaid MIT (#5) into the hump hose first, and then into the coupler. Adjust the MIT snugly against the throttle body and tighten all four clamps. Install the supplied button head bolt (#20), and washer (#21) thru the Adel clamp, and thread into the MIT. (See arrow)

18. Double check your work!

Make sure there is no foreign material in the intake path. Make sure all clamps, hoses, bolts, and screws are tight.

19. Reconnect the negative battery cable!

Thank you for purchasing the Airaid Intake System. Contact Airaid @ (800) 498-6951 8:00 AM - 5:00 PM MST weekdays for questions regarding fit or instructions that are not clear to you. Your Airaid Intake System was carefully inspected and packaged. Check that no parts are missing, or were damaged during shipping. If any parts are missing, contact Airaid. The air filter element is protected from direct exposure to water and debris; care should be taken not to drive through deep water. WATER INGESTION IS THE DRIVERS RESPONSIBILITY! The air filter is reusable and should be cleaned periodically.

FILTER IDENTIFICATION

700-458 Airaid Oiled Media
702-458 Airaid SynthaMax Dry Media - Black

701-458 Airaid SynthaMax Dry Media - Red
703-458 Airaid SynthaMax Dry Media - Blue

For your Oiled media filter we suggest using the AIRAID Filter Tune-Up Kit!



P/N 790-551 Aerosol Spray
P/N 790-550 Squeeze Spray



SynthaMax

Do Not Oil

Synthamax Air Filters do not require oil. Service air filter as needed by cleaning with common non-petroleum all-purpose household cleaner and water. Simple Green®, Formula 409® or equivalent works great. Apply cleaner to outside of air filter and allow to soak. Then flush filter clean from the inside out with a garden hose and repeat steps if necessary. Do not apply high pressure water or air to clean filter. Allow filter to air dry and reinstall.